

# *Better-Weigh Feeder*

## *Installation and Operating Instructions*

 **MetalFab, Inc.** Vernon, NJ 07462 Phone (973)764-2000 Fax (973)764-0272 [www.metalfab@metalfabinc.com](http://www.metalfab@metalfabinc.com)

### Contents:

- GENERAL DESCRIPTION
- INSTALLATION
- MAINTENANCE
- DISASSEMBLY
- ASSEMBLY
- PART LIST
- ENGINEERING DATA
  - Load Cells
  - Weigh Instruments
  - Measuring Accuracy
- BATCH CONTROL
- CONTINUOUS CONTROL



### GENERAL DESCRIPTION

When a process requires accuracies greater than 1 to 1 1/2% or it is necessary to record actual feed rates, feeding by weight loss is the only method. Although material is fed in the same volumetric manner .... the screw flights are filled to their maximum capacity with uniformly dense material .... required rates are actually monitored by a scaling system in conjunction with either a batch or continuous controller. Weight of product being delivered is continuously monitored against weight required.

The "BETTER-WEIGH" feeders are available in a variety of screw sizes and two (2) types of scaling systems. Model BWP incorporates a platform scale, which consists of our unique screw feeder design with agitator/ conditioner screws, a platform weigh scale and a controller. With the BWP, the total weight of the feeder and the weight of the product in the hopper are sensed by the load cell in the platform scale and the combined weight, which will vary based upon the bulk density of the material, determines the capacity of the load cell to be used.

Our "BETTER-WEIGH" feeder, model BWL, incorporates a lever balance scale system. With this method, the entire weight of the feeder is counter balanced so that only the contents of the hopper are weighed. This system allows for the minimal weighment of any product. open top hopper capacities of 2 to 5 cubic feet can be supplied with either model.

### INSTALLATION

***Even though we have designed our Better-Weigh® weigh assemble with stops, you can permanently damage the load cell if you drop, overload or allow anything to impact the scale. Care should be taken to eliminate these occurrences.***

The gearbox has been filled with oil and shipped with the vent plug installed. To prevent spills, Keep the feeder Upright.

The feeder should be located in an area with minimal traffic or disturbances and mounted on a stable and level support. After placing the feeder into position, remove the shipping clips from the upper and lower weighing

deck. The weigh deck's corner and load cell stops were adjusted during assembly and **should not** field adjusted. Use the wiring schematic supplied with the Better-Weigh® feeder's NEMA 4 enclosure and make your connections to the motor and load cell terminals.

If you did not purchase our optional inlet and outlet sleeves, connect the upstream and downstream equipment with flexible connections. We recommend a thin natural rubber or similar type material be used with enough slack to prevent mechanical sticktion. The more flexible the connections are, the better the accuracy you can achieve.

# **Better-Weigh- Feeders**

## **Installation and Operating Instructions**

 **MetalFab, Inc.** Vernon, NJ 07462 Phone (973)764-2000 Fax (973)764-0272 www.metalfab@metalfabinc.com

**Note: There should be no rigid connections between earth and the Better-Weigh® feeder scale platform.**

### **MAINTENANCE**

Our standard Better-Weigh® Feeders are supplied with metering screws having a standard agitator/conditioner. Their purpose is to provide a constant supply of densified product to the metering screw.

Standard machines use a "CinchSeal" rear seal. This is a Mechanical Seal.

It is made up of an elastomer insert, which is held on the drive shaft by a spring steel compression ring and rotates with the shaft while pressing the two rotors against both end plates.

There should be no product leakage. If there is, remove the threaded plug on the side of spacer blocks and using a screwdriver, tighten the compression ring in \_ turn increments.

If the seal is hot to the touch, loosen the compression ring.

***As a rule of thumb, the compression ring should only be "three fingers tight".***

All of the gearboxes are shipped with oil unless otherwise specified. It's recommend that after the first 500 hours or 4 weeks of operation, and after each succeeding 2500 hours of operation or every 6 months thereafter (which ever occurs first) drain the oil, flush out the case and refill to proper level using the recommended oil or equivalent.

For normal operating conditions where the surrounding temperatures are within the limits of 50° F to 120° F, use AGMA Lubricant #8 COMP, 8EP or similar oil of equal viscosity and composition. Below 50° F, use an AGMA Lubricant #7 COMP, 7EP or equal.

The approximate oil capacities of the 2100 gearbox is 18 and the 2400 gearbox is 21 ounces.

As with our other DB1 volumetric feeder models, the Better-Weigh® feeder is normally supplied with a 1 HP DC shunt wound (having two fields in series) DC TEFC motor. When using a SCR DC control having a 230/1/60 VAC input, the motor must be configured for 180 VDC Armature and 200 VDC connections. When using a SCR DC control having 115 VAC input, the motor must be configured for 90 VDC Armature and 100 VDC connections.

The motor's wiring is terminated in a separate NEMA 4 enclosure mounted on the feeder base. When connecting the motor, follow the schematic supplied in the enclosure.

The Better-Weigh® feeder's load cell is sized for each application. As with the drive, the load cell connections are terminated in the same NEMA 4 enclosure. Follow the load cell instructions on the schematic supplied in the enclosure.

### **FEEDER DISASSEMBLY**

To remove the screw; first remove the guard, loosen the packing box's compression ring and hollow shaft gearbox's setscrews. Unbolt the tube from the feeder's trough and remove the tube followed by the screw.

The gearbox, packing box, trough, hopper and cover can be removed by unbolting the individual items.

### **FEEDER ASSEMBLY**

The original packing box and tube gaskets can be reused. We recommend that the trough and hopper gaskets be inspected and replaced if required. If the screw and tube were the only items removed, simply reverse the disassembly instructions listed above.

packing box and gearbox. Bolt the tube into place and tighten the hollow shaft gearbox setscrews.

If the Better-Weigh Feeder is completely disassembled, the following applies. The trough, packing box and gearbox should be loosely bolted in place. Insert the screw through the trough,

Line up the gearbox, screw and trough and tighten the bolts holding the trough to the weigh deck. Turn the screw by hand and check for interference and alignment. The gearbox and packing box can be tightened at this time.

**Better-Weigh- Feeders**  
**Installation and Operating Instructions**

**Metalfab, Inc.** Vernon, NJ 07462 Phone (973)764-2000 Fax (973)764-0272 www.metalfab@metalfabinc.com

**Parts List**

- A. Sleeve Bearing
- B. Agitator/Conditioner Metering Screw
- C. Tube
- D. Load Cell
- E. Inlet Sleeve (Optional)
- F. Outlet Sleeve (Optional)
- G. Dust Filter (Optional)

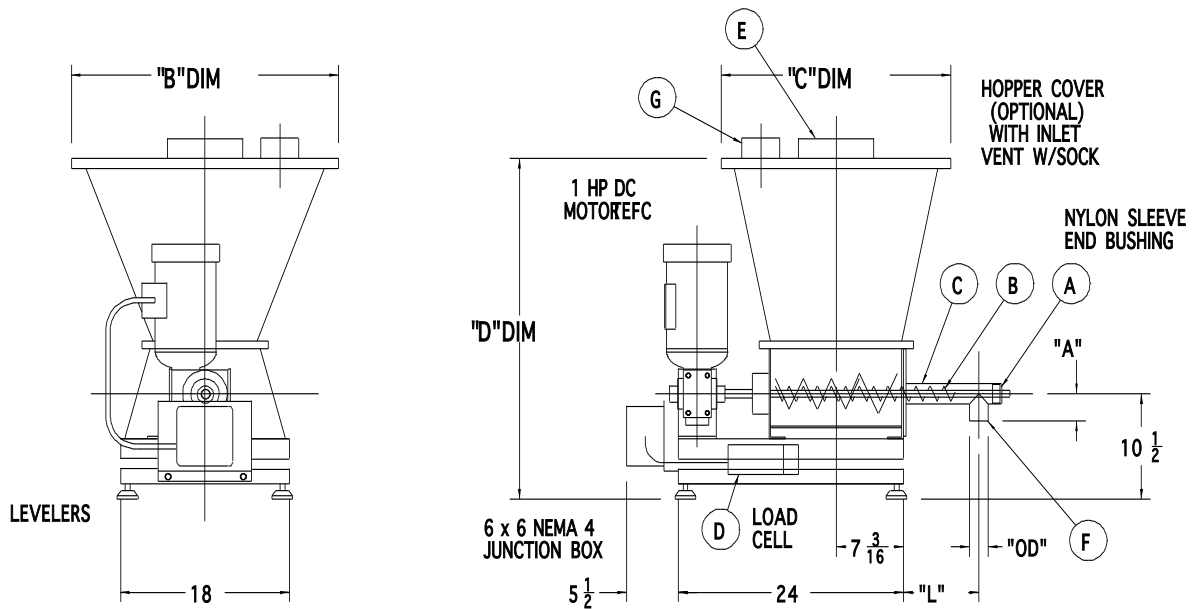

MODEL	"OD"DIM	"L"DIM	"A"DIM
BWP-1	1-1/2	8	2-3/4
BWP-1 1/2	2	8	2-3/4
BWP-2	2-1/2	8	2-3/4
BWP-3	3-1/2	12	3-1/4

HOPPER SIZE	"B"DIM	"C"DIM	"D"DIM
2 CU FT	24 1/2	22 1/2	30
3 CU FT	28 1/2	24 1/2	34
5 CU FT	30 1/2	28 1/2	38

# Better-Weigh- Feeders Installation and Operating Instructions

 **MetalFab, Inc.** Vernon, NJ 07462 Phone (973)764-2000 Fax (973)764-0272 www.metalfab@metalfabinc.com

## ENGINEERING DATA

### Load Cells:

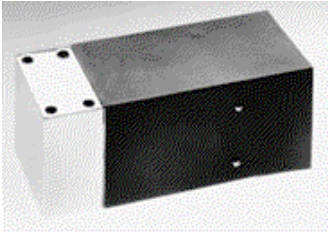

A load cell is a strain gage mounted on a machined and calibrated piece of metal. The metal can be carbon steel, stainless steel or aluminum.

The capacity of a Load Cell is = to Dead Load + Live Load

The Dead Load is equal to the machine's weight.  
The Live Load is equal to the material's weight.

### Weigh Instruments:

The system accuracy is dependent on how well the weigh instrument can convert the load cell signal to digital information and how it averages, filters and tabulates those same digits.

The weigh instrument begins the process by supplying an excitation voltage (usually 10 volts DC) which excites the cell. The returning voltage to the instrument is DC, measured in miliVolts. The value of the signal is dependent on the strain on the cell (in our case, weight).

The weigh instrument must convert the returned load cell signal into digital data. During the machine calibration, we place known weights on the scale and tell the

instrument what the weights values are. Then the instrument uses those values to calculate a linear line for signal verses weight values.

Resolution is the number of pieces that the whole load cell signal is divided by. If we divide the signal by 10, we then have ten counts of resolution or ten grads or ten graduations. One thousand divisions would be one thousand counts of resolution.

The number of resolution is set by the capacity of the load cell divided by divisions we want to see on the weigh instrument's display.

$$\begin{aligned} \text{Load Cell Capacity} / \text{Display Div.} &= \text{Resolution} \\ 500 \text{ pound cell} / .01 \text{ (Display Div.)} &= 50,000 \text{ counts of resolution} \end{aligned}$$

The majority of the weigh instrument manufacturers advertise up to one million counts of resolution.

cases 1:30,000 counts of resolution will provide a good stable reading.

All weigh systems are only as good as their load cells. 1:10,000 is used for legal for trade applications, in most

When you divide the signal by the resolution number, each graduation will have a voltage value. The value of each graduation can be found by:

$$\begin{aligned} \text{Excitation Voltage} \times \text{miliVolt} / \text{Volt} \times 1000 \text{ Resolution} \\ = \text{MicroVolt} / \text{Count (grad)} \end{aligned}$$

It is important to keep the microVolt / Grad as large as possible. Or another way of saying it would be:  
Use the smallest resolution for the largest graduation value. All our instruments have digital averaging, filtering and vibration elimination. When talking about digital averaging, we need to understand Running Averaging.  
Usually the first step during calibration is to input a digital average value or use the default settings. After calibration, the instrument waits until it has counted its first averages.

If we have the averaging set at 12, the instrument waits until it has 12 digits and then it calculates its first average. That digital average is dropped to a register and waits for digit number 13. Another average is done and that value is added to the register. The weigh instrument's display reflects the digits that were dropped to the averaging register. An important thing to remember is that after the instrument waits for the first 12 digits, the register is updated every time another digit is added.

# **Better-Weigh- Feeders**

## **Installation and Operating Instructions**

 **MetalFab, Inc.** Vernon, NJ 07462 Phone (973)764-2000 Fax (973)764-0272 www.metalfab@metalfabinc.com

Both of our instruments use Filtering (vibration elimination). Think of vibration elimination as “Magic Numbers”.

In most cases “Magic Numbers” are an asset. But as with everything else, there is a limit.

We like the fact that the “Magic Numbers” eliminates repetitive noise, but too much filtering dampens your

readings. When changing the filtering settings, you sacrifice time. The higher the setting, the longer it takes to make that filtering calculation.

### **MEASURING ACCURACY:**

When testing one of our Better-Weigh® Feeders, we catch 30 consecutive one minute samples.

The plus & minus deviation of these samples are analyzed using 2 Sigma deviation formulas.

When sampling, 65% of the samples will fall within one standard deviation or (1) Sigma and 95% will fall within two standard deviations or (2) Sigma. The loss-in-weight industry has standardized on the 2 Sigma as an accuracy statement.

### **CONTROL FEATURES - "BETTER-WEIGH"® BATCH LOSS-OF-WEIGHT FEEDER**

With the "BETTER-WEIGH" batch feeder model BWP, accuracies of  $\pm 0.5\%$  can be achieved with 2 lb. batches and  $\pm 0.25\%$  accuracy with 5 lb. or greater batches with time spans of 30 to 90 seconds. The BWL model can easily produce an accuracy of  $\pm 0.5\%$  in 1 lb. batches.

The METALFAB batch controller is used to control the fast (bulk) and slow (dribble) speeds of our "BETTER-WEIGH"® feeders.

1. The bulk dribble targets are entered through the front panel or down loaded to the indicator using RS-232 or optional RS-485 and Allen Bradley Blue Hose communications. The feeders fast and slow speeds are set manually and are initiated by the weigh indicator's twenty (20) programmable steps.
2. In addition to the fast and slow speed outputs, the indicator has two (2) additional outputs which can be configured for a refill, batch complete or general alarm conditions.
3. Formatting printing can be done and is activated by one of the programmable steps or by pushing the print button located on the front panel.

4. The indicator is also supplied with four accumulators and their values printed through the print functions.
5. Vibration elimination is used to remove motor and machine noise from the raw digital data used for weigh indication. It is also an added benefit when using vibration to assist with feeding.
6. Both the SCR DC drive and weigh indicator are mounted in the same NEMA 4 enclosure having a power on/off switch with light, Jog/Batch and Abort/Start selector switches.
7. Normally the control is supplied 230/1/60 VAC As an option, 115/1/60 VAC can be supplied.

**For a detailed description of the Batch Control and installation, calibration and operating instructions, refer to the schematics and instructions enclosed in our control enclosure.**

# **Better-Weigh- Feeders**

## **Installation and Operating Instructions**

 **MetalFab, Inc.** Vernon, NJ 07462 Phone (973)764-2000 Fax (973)764-0272 www.metalfab@metalfabinc.com

### **CONTROL FEATURES - "BETTER-WEIGH" CONTINUOUS LOSS-OF-WEIGHT FEEDER**

Unlike the batch loss-of-weight feeders, the continuous weighers deliver an ongoing flow of material. The loss-of-weight of material per time is constantly monitored in order to maintain a continuous loss-of-weight with an accuracy of  $\pm 0.25\%$  to  $0.5\%$  with (1) minute samples.

The METALFAB continuous controller is used to control the speed of our "BETTER-WEIGH" feeders based on the amount of material weight loss within a time period.

1. The rate targets are entered through the front panel or can be down loaded to the indicator using RS-232, optional RS-485 or Allen Bradley Blue Hose communications.
2. After our "BETTER-WEIGH" continuous controller has been installed, load cell and automatic rate calibrations are performed. The Proportion, Integral and Derivative factors are automatically calculated and stored in the indicator. This eliminates the trial and error methods used by other manufacturers.
3. Operation of the control can be manual, continuous or continuous batching. In all modes of operation, the indicator monitors material

gross weight and initiates automatic refills with high and low level alarms.

4. The feed rate can be set for lbs./sec., lbs./min. or lbs./hr. A rate tolerance input is used to **provide a band for monitoring** the indicator's performance. If the rate is operating out of tolerance for a set time, the indicator will output an alarm and can be programmed to automatically shut down the feeder.
5. The indicator uses vibration elimination to remove noise from the raw digital data used for weigh indication. The sensitivity can be preset to eliminate noise from machines, motors or vibrators.
6. As with our batch feeder control, both the SCR DC drive and weigh indicator are mounted in the same NEMA 4 enclosure having a power on/off switch with **light and** indicator keypad and display.
7. The control is supplied as 230/1/60 VAC. As an option, 115/1/60 VAC can be supplied.

**For a detailed description of the Continuous Control and installation, calibration and operating instructions, refer to the schematics and instructions enclosed in our control enclosure.**

**MetalFab has designed our**  
**Better-Weigh® machines to have:**  
**The minimal "Dead Load"**  
**The maximum "Live Load"**  
**To use the smallest load cell capacity**  
**With the biggest Resolution**